

# RSA 13

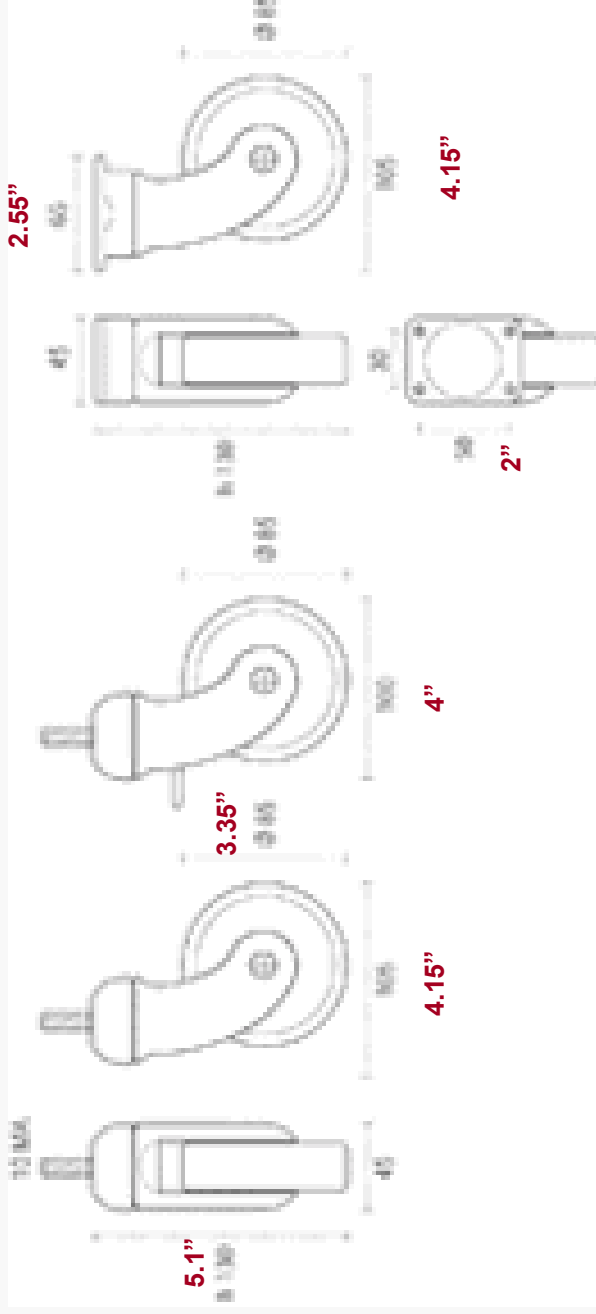
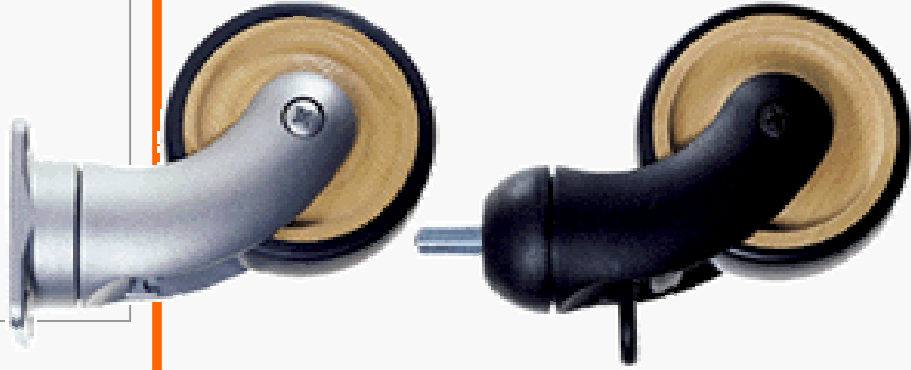

**LEGEND**

80 = measurement in millimeters

4" = measurement in inches

*Note: please call to discuss options & for correct part numbers*

PART #	MATERIAL	HEIGHT	FINISH OPTIONS	BRAKE	ATTACHMENT	MAX LOAD	PACK SIZE
20RSA13xxxxx	PLASTIC	5.1" (130mm)	CHERRY BEECH NUT BROWN CHROME BLACK SILVER LACQUER	Available with or without brake	BOLT or PLATE	130KG	48PCS